



 - **Facade PRO+**

Solar Facades Without Limits

Product Design  
Consultant

**Gensler**

Energy Generating Building Materials:  
eFacade PRO+ Product Datasheet

 **MITREX™**

## ⚡ eFacade PRO+

eFacade PRO+ by Mitrex is a highly customizable building-integrated photovoltaic (BIPV) system that enables architects and developers to realize any facade concept without compromising on solar performance. PRO+ is designed to support unique project requirements, whether you're building with complex geometries, specific color palettes, or non-standard system types.

Each module is engineered to deliver up to 18W/ft<sup>2</sup> of solar generation while allowing complete freedom in dimensions, shapes, and finishes. With compatibility across ventilated rainscreens, unitized curtain walls, and prefabricated facade assemblies, eFacade PRO+ adapts to the most advanced and demanding architectural applications.

Mitrex collaborated with Gensler, serving as product design consultant, for eFacade PRO+ (Aluminum Honeycomb Backing)

Product Design Consultant **Gensler**

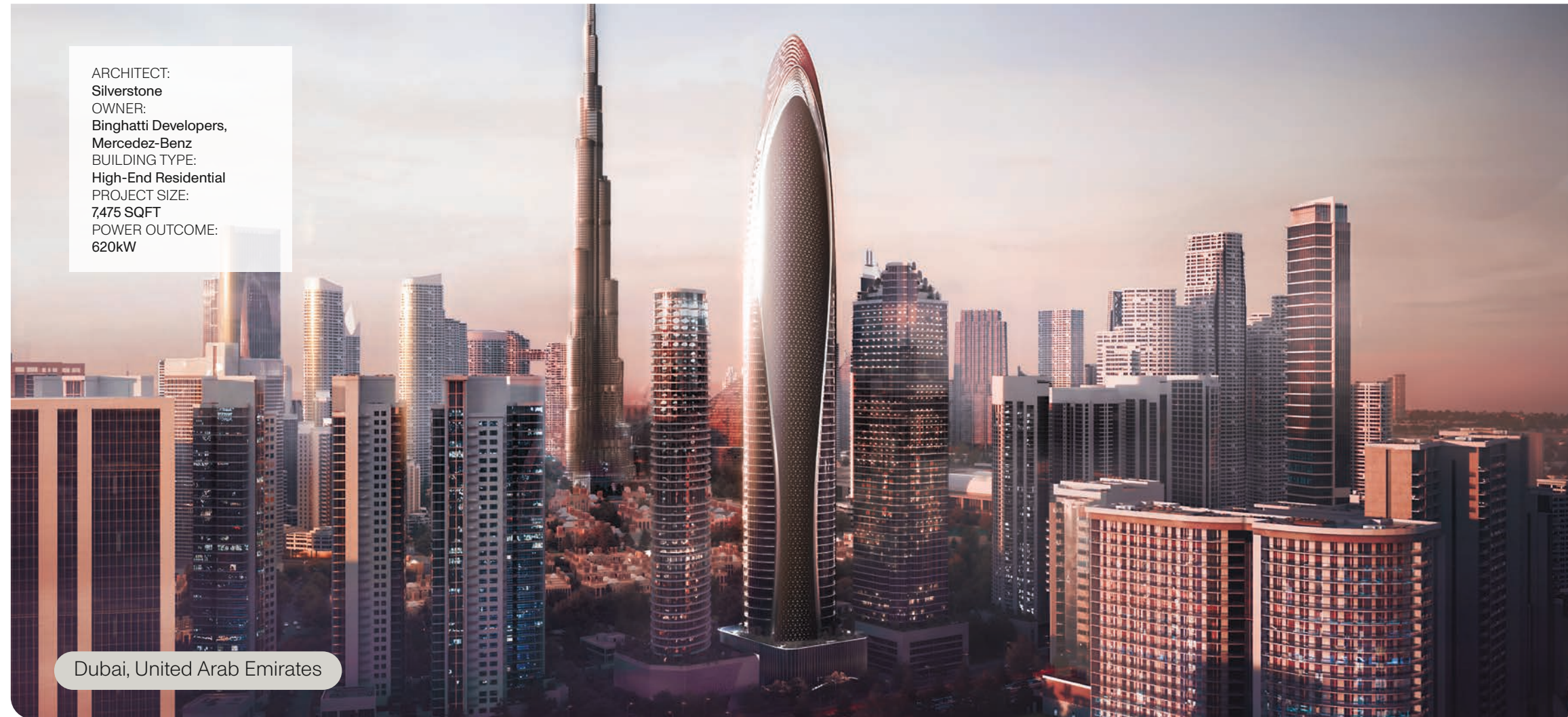

ARCHITECT:  
Silverstone  
OWNER:  
Binghatti Developers,  
Mercedes-Benz  
BUILDING TYPE:  
High-End Residential  
PROJECT SIZE:  
7,475 SQFT  
POWER OUTCOME:  
620kW

Dubai, United Arab Emirates

### ☀️ Installation System

Compatible with rainscreen, unitized, stick-built, and curtain wall systems—also available as prefabricated modules, slab-to-slab connections, or insulated wall assemblies.

### 🎨 Custom Aesthetics

Allows complete design freedom with limitless color options, shapes, graphic overlays, and finishes like satin, matte, glossy, and wood grain—enabling full customization to suit any architectural vision or branding need.

### 📏 Sizes & Shapes

Fabricated in nearly any size or shape, accommodating everything from compact units to oversized formats—including tilted modules, rectangles, triangles, curves, and integrated corners.

### ♻️ Sustainability

Supports long-term carbon reduction by generating clean energy and incorporating recyclable, low-carbon materials. It's designed to help projects meet LEED, Passive House, and other sustainability standards.

### 🛡️ Certifications

Meets safety standards including UL 61730, UL 61215, ASTM E1996 for impact resistance, and ASTM E330 for wind load performance.

### 🔥 Fire Safety

Features a non-combustible glass and a tested backing system to meet strict global fire safety standards, including EN 13501 A2-s1,d0 and NFPA 285.

### 🌞 Performance

Built for long-term durability outdoors, tested for UV resistance, temperature extremes, and mechanical impact, and performs reliably between -40°C and +85°C.

### 🔧 Maintenance

With self-cleaning glass and corrosion-resistant materials, this system requires minimal maintenance. Its sealed photovoltaic design ensures long-term reliability and is backed by a 25-year power performance warranty.

### 💰 Incentives

Projects using this system may qualify for sustainability incentives such as government rebates, green energy grants, and low-cost financing across North America.

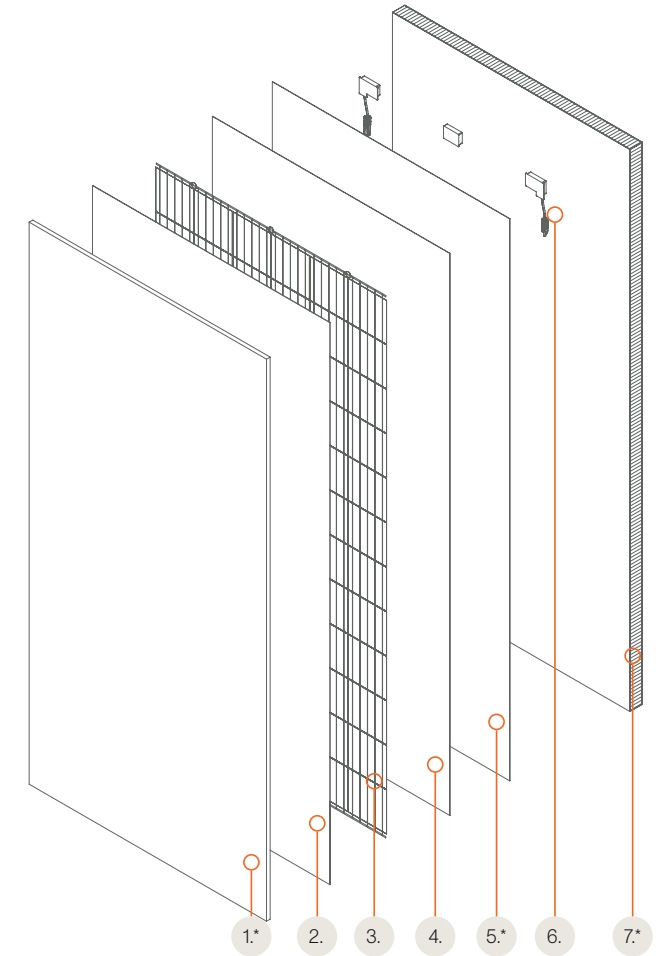

### eFacade PRO+ Module Details

1. Glass / Customizable Facing - \* See page 6 - 9
2. and 4. Encapsulant
3. ⚡ Solar Cells
5. Back Sheet - \*See page 10, Section Solar Backsheet Capabilities
6. Junction Box
7. Aluminum Honeycomb or Extruded Aluminum Profile - \* See page 11 - 12

## General Electrical And Mechanical Data - Aluminum Honeycomb

Standard Module 2030 × 990 mm (79.9 × 39.0 in)

Test	Specification	Engineering Drawing	
<b>Test Conditions</b>	<b>STC</b>		
Module Power (Pmax)	Varies depending on color, contact us for more information Toll Free: +1 (855) 254-0214 Email: info@mitrex.com		
Maximum Power Voltage (Vpmax)			
Maximum Power Current (Ipmax)			
Open Circuit Voltage (Voc)			
Short Circuit Current (Isc)			
Module Efficiency			
Cell Efficiency			22.5% - Monocrystalline Solar Cell
Maximum System Voltage (VDC)			1000V (IEC/UL)
Series Fuse Rating			20A
Power & Other Electrical Specification Tolerance		5%	
Application Classification	Class A		
<small>Measurement Conditions: STC 1000 W/m<sup>2</sup> - AM 1.5 - Temperature 25°C</small>			

Mechanical Properties	Metric	Imperial
Module Weight	32.3kg / 46.4kg	71.0lbs / 102.0lbs
Dimensions (H x L x D)	2030 × 990 × 55mm / 2030 × 990 × 58mm	79.9 × 39.0 × 2.16in / 79.9 × 39.0 × 2.28in
Maximum Surface Load (Wind / Snow)	8000Pa rear load / 8000Pa front load	167.1psf rear load / 167.1psf front load
Design Load	5400Pa rear load / 5400Pa front load	112.7psf rear load / 112.7psf front load
Hail Impact Resistance	ø 25mm at 83 km/h	ø 1in at 51.6 mph
Cells	72 [12×6] Mono-crystalline (158.75 × 158.75mm)	72 [12×6] Mono-crystalline (6.25 × 6.25in)
Glass	3.2mm / 6mm tempered glass, high transmittance, anti-reflective coating	0.125in / 0.23in tempered glass, high transmittance, anti-reflective coating
Cables & Connectors	1200mm - 4mm <sup>2</sup> , 12 AWG (UL), MC4 from Staubli	47.2in - 0.16in <sup>2</sup> , 12 AWG (UL) MC4 from Staubli
Backsheet	High durability, UV resistant, PV backsheet	
Back Support	Aluminum Honeycomb	
Bypass Diodes	3 diodes- 30SQ045T (45V max DC blocking voltage, 30A max forward rectified current)	
Junction Box	IP68 rated, TUV and UL certified	
Fire Rating	Spread of Flame A, Burning Brand C	

Temperature Ratings	I-V Curves
Temperature Coefficient Isc	0.036% /°C
Temperature Coefficient Voc	-0.27% /°C
Temperature Coefficient Pmax	-0.36% /°C
Nominal Module Operating Temperature	45 ± 3°C
Operating Temperature	-40°C ~ +85°C

**Irradiances**

**Temperatures**

\*Varies, These graphics are based on a 345W panel

## General Electrical And Mechanical Data - Extruded Aluminum Profile

Standard Module 2034 × 994 mm (80 × 39.1 in)

Test	Specification	Engineering Drawing	
<b>Test Conditions</b>	<b>STC</b>		
Module Power (Pmax)	Varies depending on color, contact us for more information Toll Free: +1 (855) 254-0214 Email: info@mitrex.com		
Maximum Power Voltage (Vpmax)			
Maximum Power Current (Ipmax)			
Open Circuit Voltage (Voc)			
Short Circuit Current (Isc)			
Module Efficiency			
Cell Efficiency			22.5% - Monocrystalline Solar Cell
Maximum System Voltage (VDC)			1000V (IEC/UL)
Series Fuse Rating			20A
Power & Other Electrical Specification Tolerance		5%	
Application Classification	Class A		
<small>Measurement Conditions: STC 1000 W/m<sup>2</sup> - AM 1.5 - Temperature 25°C</small>			

Mechanical Properties	Metric	Imperial
Module Weight	37.8kg	83.1lbs
Dimensions (H x L x D)	2034 × 994 × 34mm	80 × 39.1 × 1.3in
Maximum Surface Load (Wind / Snow)	8000Pa rear load / 8000Pa front load	167.1psf rear load / 167.1psf front load
Design Load	5400Pa rear load / 5400Pa front load	112.5psf rear load / 112.7psf front load
Hail Impact Resistance	ø 25mm at 83 km/h	ø 1in at 51.6 mph
Cells	72 [12×6] Mono-crystalline (158.75 × 158.75mm)	72 [12×6] Mono-crystalline (6.25 × 6.25in)
Glass	6mm tempered glass, high transmittance, anti-reflective coating	0.23in tempered glass, high transmittance, anti-reflective coating
Cables & Connectors	1200mm - 4mm <sup>2</sup> , 12 AWG (UL), MC4 from Staubli	47.2in - 0.16in <sup>2</sup> , 12 AWG (UL) MC4 from Staubli
Backsheet	High durability, UV resistant, PV backsheet	
Frame	Extruded aluminum profile	
Bypass Diodes	3 diodes- 30SQ045T (45V max DC blocking voltage, 30A max forward rectified current)	
Junction Box	IP68 rated, TUV and UL certified	
Fire Rating	Type II	

Temperature Ratings	I-V Curves
Temperature Coefficient Isc	0.036% /°C
Temperature Coefficient Voc	-0.27% /°C
Temperature Coefficient Pmax	-0.36% /°C
Nominal Module Operating Temperature	45 ± 3°C
Operating Temperature	-40°C ~ +85°C

**Irradiances**

**Temperatures**

\*Varies, These graphics are based on a 345W panel

## Solar in any Color, Pattern, or Texture

There are no limitations when it comes to architectural creativity with Mitrex eFacade PRO+. This cutting-edge solar facade system empowers designers with unmatched freedom to bring any vision to life.

Whether you have a specific color in mind, are targeting an exact RAL or Pantone® shade, or want to replicate the look of natural stone, concrete, wood, or metal, or even incorporate bold graphic visuals, eFacade PRO+ can seamlessly match virtually any material, color, or texture using advanced surface treatment technology. Each module turns the building envelope into a solar-powered canvas, blending high-performance energy generation with complete aesthetic freedom. With eFacade PRO+, beauty and sustainability are seamlessly integrated, allowing architects to design truly distinctive facades without compromise.

### Module Finish

Unlimited customization in pattern, texture, and color to meet any architectural vision

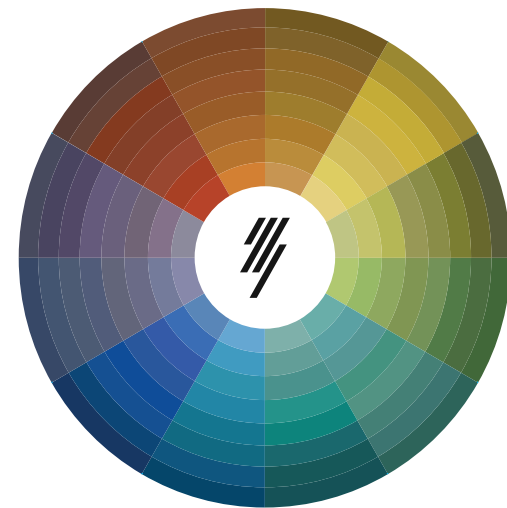

### Unlimited Color

More custom colors are available. Ask one of our representatives how to get a sample color for your project.

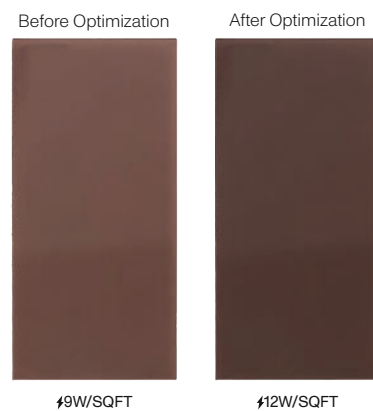

### Performance Optimization

Note: Power outcome is for a 2030x990mm module. Other module sizes will affect the output.

### Design Flexibility

Full design flexibility with customizable module sizes (up to 125in x 80in), curved modules, and integrated corner solutions

### Glass Textures

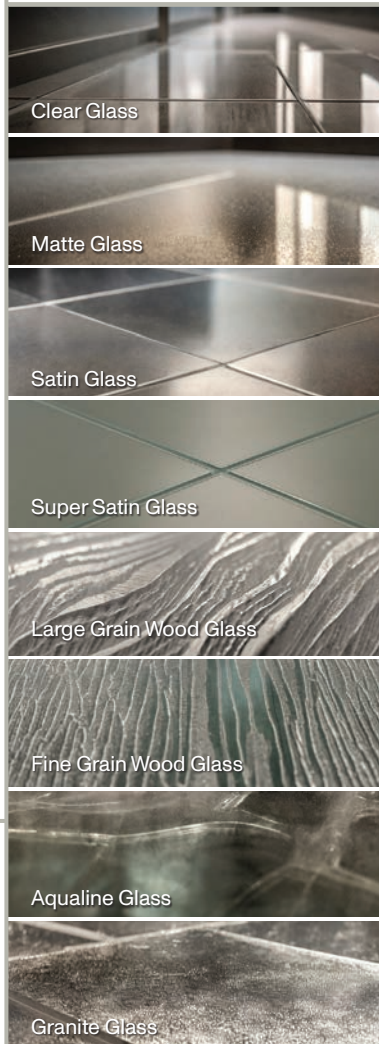

### Facings Variety

Available in reflective, semi-reflective, satin, matte, glossy, and specialty glass finishes



### Matching Regular Materials



For more information about the capabilities of eFacade PRO+, scan the QR code.



### Unlimited Pattern Options



With Mitrex eFacade PRO+, the possibilities are limitless

## Colors and Patterns Ideas

Mitrex eFacade PRO+ offers unlimited design possibilities with customizable colors, patterns, and finishes to match any architectural vision. From natural textures to bold, contemporary designs, the options are endless. Included here is a sample of our Genesis and Exodus color lines—just a glimpse of the wide range of aesthetics available through our advanced solar cladding technology.

### Mitrex Genesis Series

Mitrex Genesis Solar Series seamlessly blends aesthetics with innovation, offering a diverse range of color options that can be optimized to meet any design vision. These advanced solar facings provide both energy generation and architectural versatility, redefining the possibilities of sustainable building design.

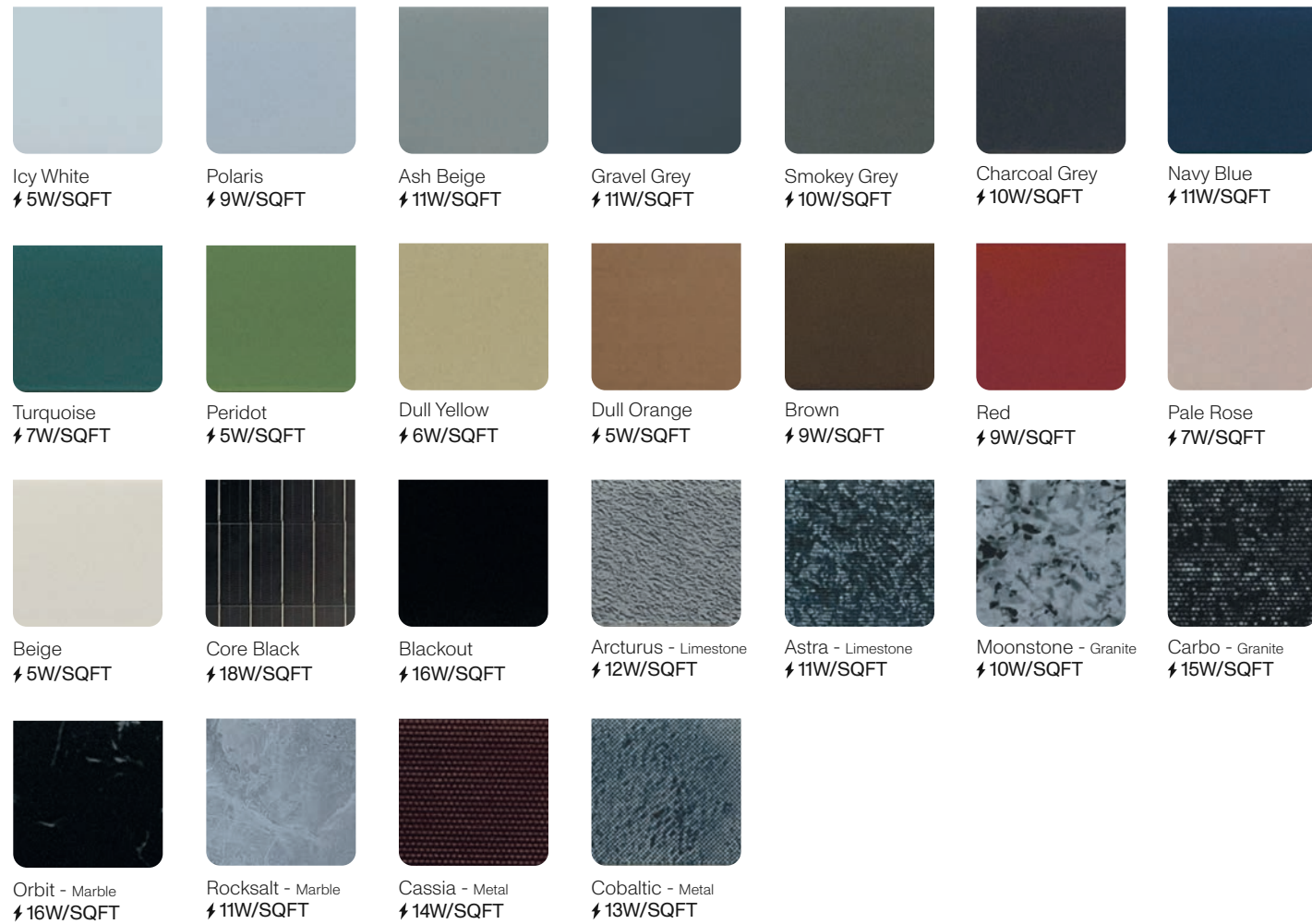

**ORDER A FREE SAMPLE!**  
Experience the look and feel of our solar cladding. Scan the QR code or visit [www.mitrex.com](http://www.mitrex.com) to order your free Mitrex sample today.

### Mitrex Exodus Series

Delivers a sleek, uniform aesthetic with a single-color design per module, ensuring a consistent and sophisticated look. While the color options are fixed, these high-performance solar facings seamlessly integrate renewable energy into any architectural project.

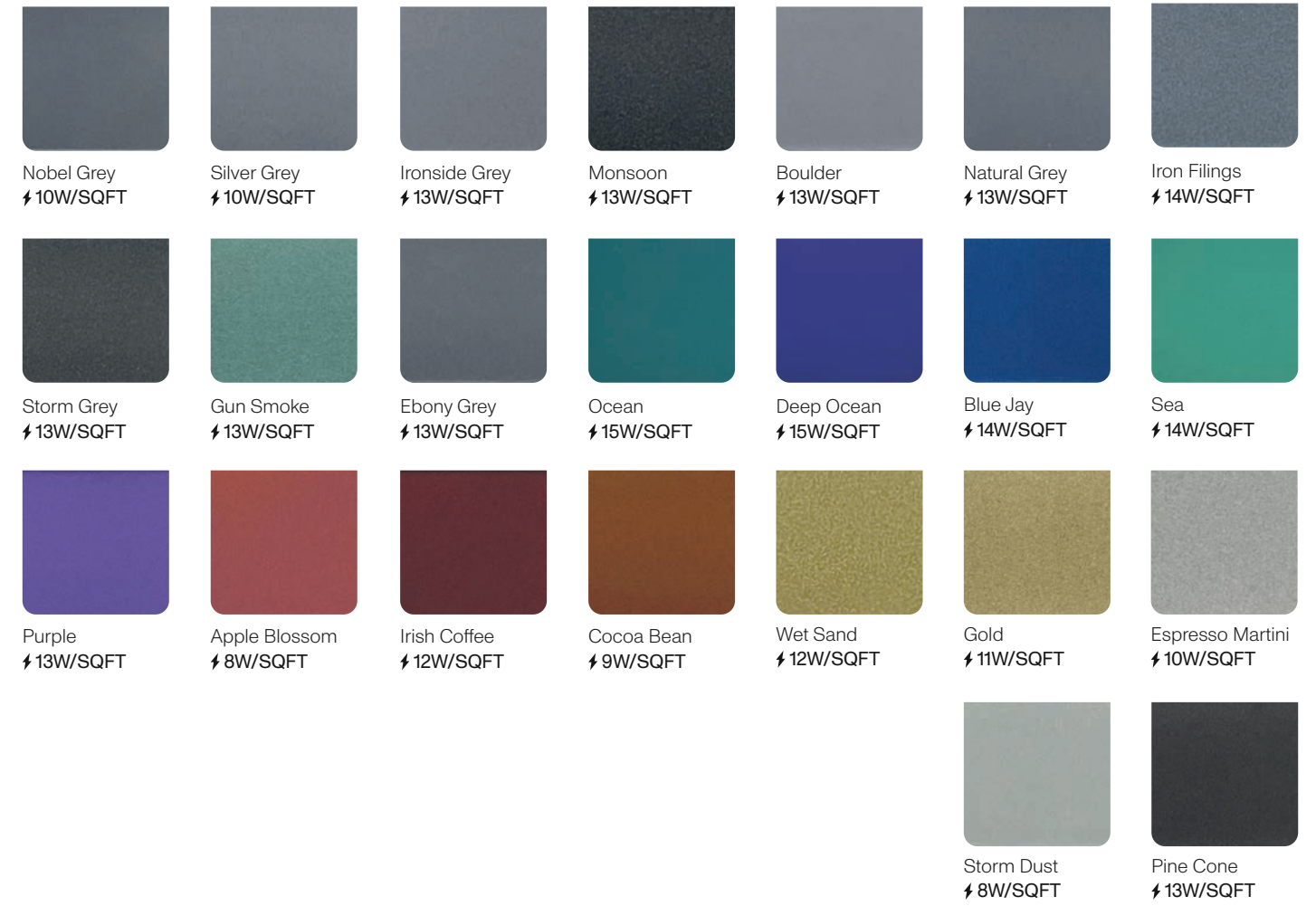

## Size & Shapes Details

### Size Capabilities

eFacade PRO+ can be fabricated in virtually any size, from compact modules to oversized formats. Available in fully customizable sizes up to 125 x 80 inches, PRO+ supports a wide range of shapes including tilted modules, rectangles, triangles, curves, and integrated corner modules.

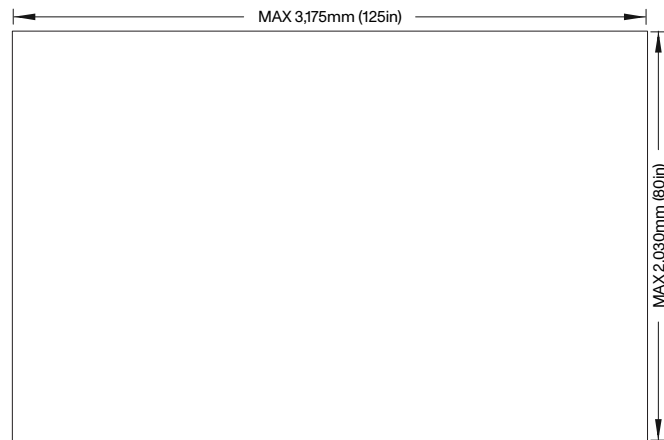

### Shapes & Curving Capabilities

eFacade PRO+ offers a wide range of shapes—from elegant circles and sharp triangles to precise hexagons and more unconventional forms. It also enables curved modules with a minimum radius of R=1800mm or L/18, adding a sleek, modern touch to any design.

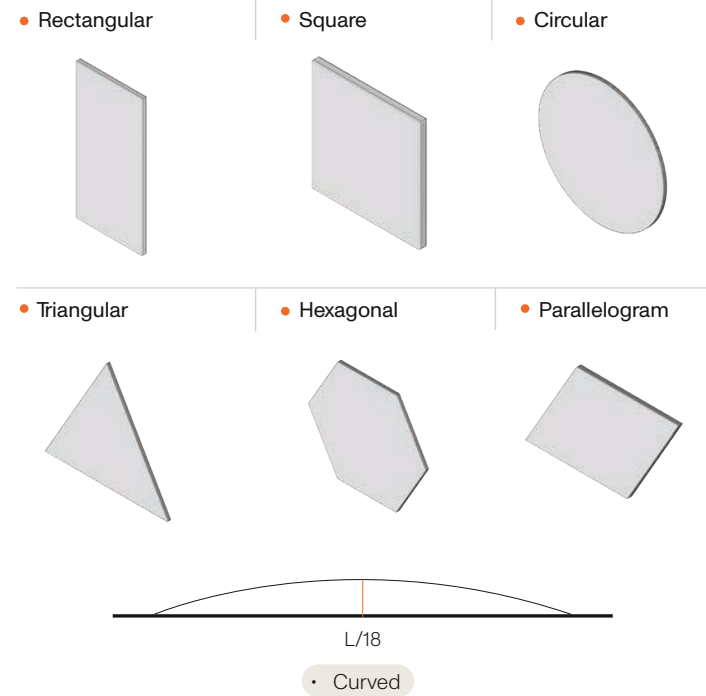



### Solar Glass Facing Specification

	Certification	Imperial	Metric
Density	ASTM C729	158lb/ft <sup>3</sup>	2,530kg/m <sup>3</sup>
Absorption By Wt.	ASTM C373	0%	0%
Compressive Strength	-	150,000psi	1,000MPa
Flexural Strength (Dry)	ASTM C158	8,700psi	60MPa
Modulus Rupture	ASTM C158	5,950psi	41MPa
Hardness	ASTM C730	570KHN	

For further mechanical information about solar glass, please check Mitrex solar glass datasheet.

### Solar Backsheet Capabilities

Backsheet	High durability, UV resistant, PV backsheet
Color	<div style="display: flex; align-items: center; gap: 10px;"> <div style="text-align: center;">  White Backsheet                 </div> <div style="text-align: center;">  Black Backsheet                 </div> </div>

## Backing Details - Aluminum Honeycomb

### General Module Mechanical Data

	• Size 1 in		• Size 2 in	
	Imperial	Metric	Imperial	Metric
0.13in / 3.2mm Glass Facing				
Total Thickness With Facing	1.15in	29mm	2.15in	55mm
Total Weight With Facing	2.84lbs/ft <sup>2</sup>	13.89kg/m <sup>2</sup>	2.97lbs/ft <sup>2</sup>	14.5kg/m <sup>2</sup>
0.23in / 6mm Glass Facing				
Total Thickness With Facing	1.25in	32mm	2.25in	57mm
Total Weight With Facing	1.90lbs/ft <sup>2</sup>	39kg/m <sup>2</sup>	2.90lbs/ft <sup>2</sup>	64kg/m <sup>2</sup>

### Aluminum Honeycomb General Mechanical Data

	• Size 1 in		• Size 2 in	
	Imperial	Metric	Imperial	Metric
Total Thickness	1in	25.4mm	2in	50.8mm
Skin Thickness	0.03in	1mm	0.03in	1mm
Weight	0.96lb/ft <sup>2</sup>	4.67kg/m <sup>2</sup>	1.08lb/ft <sup>2</sup>	5.28kg/m <sup>2</sup>
Flexural Rigidity	182 (10 <sup>9</sup> N psi)	1.26 (10 <sup>9</sup> N mm <sup>2</sup> )	1,450 (10 <sup>9</sup> N psi)	10.08 (10 <sup>9</sup> N mm <sup>2</sup> )
Shear Rigidity	332 (10 <sup>9</sup> N psi)	2.29 (10 <sup>9</sup> N mm <sup>2</sup> )	332 (10 <sup>9</sup> N psi)	2.29 (10 <sup>9</sup> N mm <sup>2</sup> )
Tensile Strength	196 psi	1.35 MPa	392 psi	2.70 MPa
Compressive Strength	15,664 psi	108 MPa	31,328 psi	216 MPa
Compressive Elastic Modulus	101 psi	0.7 MPa	203 psi	1.4 MPa
Shear Strength	1,232 psi	8.5 MPa	2,465 psi	17 MPa

Thickness Options



### Aluminum Honeycomb Mechanical Data - Skin

	Imperial	Metric
Thickness	0.02 - 0.04in	0.5 - 1mm
Yield Strength (R <sub>p,0.2</sub> )	>11,603 psi	>80 N/mm <sup>2</sup>
Ultimate Tensile Strength (R <sub>m</sub> )	18,129<R <sub>m</sub> <26,831psi	125<R <sub>m</sub> <185 N/mm <sup>2</sup>
Elongation (A)	>3%	
Alloy Type	5005	

For further mechanical information about aluminum honeycomb, please check Mitrex aluminum honeycomb datasheet.

### Aluminum Honeycomb Mechanical Data - Core

	Imperial	Metric
Thickness	1/4in	6.35mm
Yield Strength (R <sub>p,0.2</sub> )	0.002in	0.05mm
Ultimate Tensile Strength (R <sub>m</sub> )	3.49lb/ft <sup>3</sup>	56 kg/m <sup>3</sup>
Elongation (A)	319 psi	2.2 MPa
Alloy Type	3005	

## Facing Details

### Solar Glass Mechanical Data

	Imperial	Metric
Thickness (0.13in / 3.2mm)	0.13 ± 0.008in	3.2 ± 0.2mm
Thickness (0.23in / 6mm)	0.23 ± 0.012in	6 ± 0.3mm
Dimensional Tolerance	± 0.04in	± 1.0mm
Density	0.09lbs/in <sup>3</sup>	2.5gm/cm <sup>3</sup>
Corner	Radius, Chamfer or cut (0.04-0.16in)	Radius, Chamfer or cut (1.0-4.0mm)
Overall Bow / Warp (EN 12150-1:2015)	0.16in / 39.37in	4.0mm/M / 990mm/M
Local Warp (EN 12150-1:2015)	0.002in / 11.81in	0.5mm / 300mm/M
Bending Strength (EN 12150-1:2015) (0.13in / 3.2mm)	516.06lbs/in	90N/mm
Bending Strength (EN 12150-1:2015) (0.23in / 6mm)	685.21lbs/in	120N/mm
Iron Content (ASS)	<120ppm	
Edge	At least seamed	
Scratch Hardness (Mohs)	5	
Fragmented Particles in 50x50mm (If Tempered) (EN 12150-1:2015)	Min 40 pcs	

## Backing Details - Extruded Aluminum Profile

	Imperial	Metric
Dimensions	1.42 x 1.22in	36.1 x 31.1mm
Weight	0.29lb/ft	0.43kg/m
Tensile Modulus	10 x 10 <sup>6</sup> psi	69 GPa
Tensile Strength	0.21 x 10 <sup>5</sup> psi	145 MPa
Shear Strength	0.17 x 10 <sup>5</sup> psi	117 MPa
Material	Aluminum Alloy	

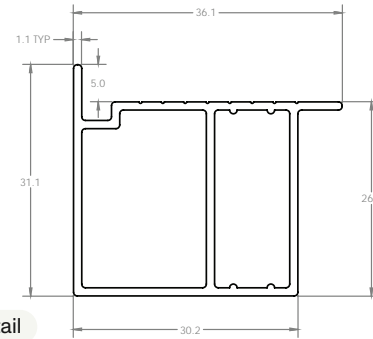

Module Frame Detail

## Installation System Details

- Cladishield System (Rainscreen System)
- Claditized System (Unitized Wall System)
- Cladifab System (Pre-fab Wall System)

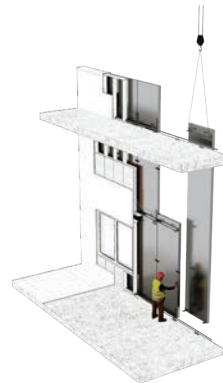
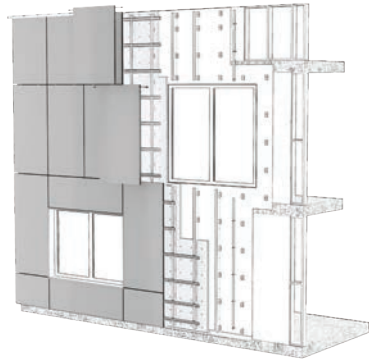

### Smoke And Flame Spread (ASTM E84)

	Rating
Mitrex Cladishield System (Rainscreen System)	Class A
Mitrex Claditized System (Unitized Wall System)	Class A
Mitrex Cladifab System (Pre-fab Wall System)	Class A

### Lifetime Warranty

- Mitrex solar facade products physically last the lifetime of the building and beyond as a building envelope product.
- The warranty guarantees that the energy generation will have a minimum energy output of 80% by year 25. However, energy generation will continue after the warranty period ends for as long as the modules are on the wall.
- Our lifetime warranty ensures reliable, durable facades as the modules require minimal maintenance and there is zero module replacement needed for the building lifetime.

### Sound Transmission Coefficient (ASTM E90)

	STC Rating
Mitrex Cladishield System (Rainscreen System)	34
Mitrex Claditized System (Unitized Wall System)	35
Mitrex Cladifab System (Pre-fab Wall System)	55

## Testing And Certifications Details

Category	Test Name	Test Specification	Result
Acoustic	Sound Transmission Loss	ASTM E90	Sound Transmission Rating: Cladishield Rainscreen: 34; Claditized Unitized: 35; Cladifab Prefab: 55
	Salt Spray Resistance	ASTM B117-16	No deleterious effects.
Environmental	Laboratory Aging of Sandwich Construction	ASTM C481-99 (Reapproved 2016)	ASTM C273; C297; C364; C393 tests were reconducted after aging: the variation was +1.36 %, -5.90%; +2.55%; -7.95%. Note: Positive variation indicates no decrease in strength after aging.
	Resistance to Rapid Freezing and Thawing	ASTM C666/C666M-15	No visible change to panel
	Air Leakage Resistance	ASTM E283-04 (2012)	Qinf = 0.031 cfm/ft <sup>2</sup> or 0.155 L/s-m <sup>2</sup> at 300 Pa; Qexf = 0.024 cfm/ft <sup>2</sup> or 0.122 L/s-m <sup>2</sup> at 300 Pa
	Fluorescent UV Exposure	ASTM G154 -16	No visible change
Fire Safety	Water Penetration Resistance	ASTM E331	No water infiltration at 15 psf or 720 Pa
	Fire Endurance Test	ASTM E119 / CAN/ULC S101	Passed
	Exterior Wall Assembly Fire Test	CAN/ULC S134	Passed
	Fire Classification	EN13501	Rating: A2-s1,d0
	Tunnel Test	ASTM E84	FSI = 10; SDI = 200; Class A
	Non-Combustibility (ASTM E136)	ASTM E136	Passed
	Multi-Story Fire Test	NFPA 285	Passed
	Surface Burning Characteristics	CAN/ULC S102	FSR = 0; Class A
	Non-Combustibility (CAN/ULC S114)	CAN/ULC S114	Passed
	Combustibility Parameters (Cone Calorimeter)	CAN/ULC S135	Passed NBCC 2015 requirements
Impact / Safety	Large Missile Impact Test	ASTM E1996 / TAS 201	Passed
	Cyclic Pressure Loading	ASTM E1886 / TAS 203	Passed. Over 3,500 positive and negative pressure cycles were applied at ± 2880 Pa (60 psf), equivalent wind load of 165 mph.
Mechanical	Shear Strength and Shear Modulus	ASTM C273/C273M-18	Ultimate core shear strength = 1.01 MPa (147 psi); Core shear modulus = 10.9 MPa (1583 psi)
	Shear Strength by Beam Flexure	ASTM C393/C393M-16	Max core shear strength = 0.94 MPa (137 psi); Facing bending stress = 8.14 MPa (1180 psi)
	Flexure Creep Evaluation	ASTM C480/C480M-16	Net creep (in/day) facing - 0.029
	Density of Sandwich Core	ASTM C271/C271M-16	327 kg/m <sup>3</sup> (20.42 lbm/ft <sup>3</sup> )
	Flatwise Tensile Bond Strength	ASTM C297/C297M-16	1.52 MPa (220 psi)
	Edgewise Compressive Strength	ASTM C364/C364M-16	37.85 MPa (5490 psi)
	Flatwise Compressive Strength	ASTM C365	1.92 MPa (278 psi)
	Flexural Strength	ASTM C880/C880M-15	22.83 MPa (3311.21 psi); No failure
	Tensile Properties of Adhesive Bond	ASTM C897-08 (2016)	Adhesive bond did not fail
	Damage Resistance	ASTM D7766/D7766M-16	No panel deformation
Structural Performance	ASTM E330	+/-80 psf or +/- 3840 Pa; no failure	
Thermal	Thermal Resistance	ASTM 1363-11	0.20 m <sup>2</sup> ·C/W (1.12 hr·ft <sup>2</sup> ·°F/BTU)
	Linear Thermal Expansion	ISO 10545-8	11.28 x 10 <sup>-6</sup> /°C
PV Quality	Terrestrial Photovoltaic (PV) Modules - Design Qualification and Type Approval	IEC/UL 61215	Passed
PV Safety	Standard for Photovoltaic (PV) Module Safety	IEC/UL 61730	Passed



## Module Corners & Edges Details

### Aluminum Honeycomb Backing

At Mitrex, every detail matters—right down to the corners and edges. eFacade PRO+ corner and edge solutions are engineered to maintain the aesthetic continuity of the building envelope while ensuring performance, safety, and durability.

Module Edge Flushed

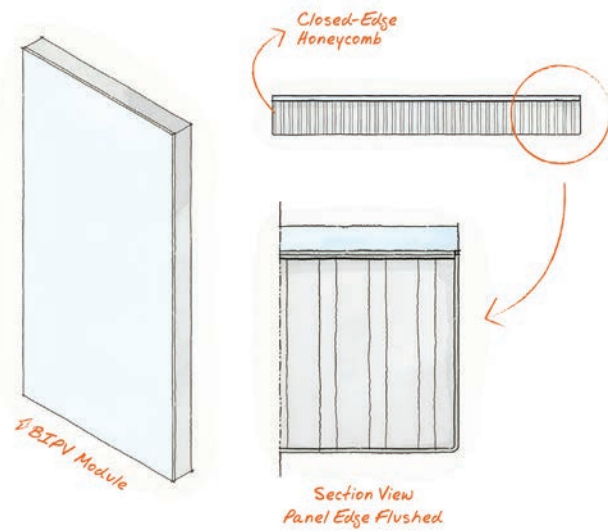

Module Edge With L-Angle

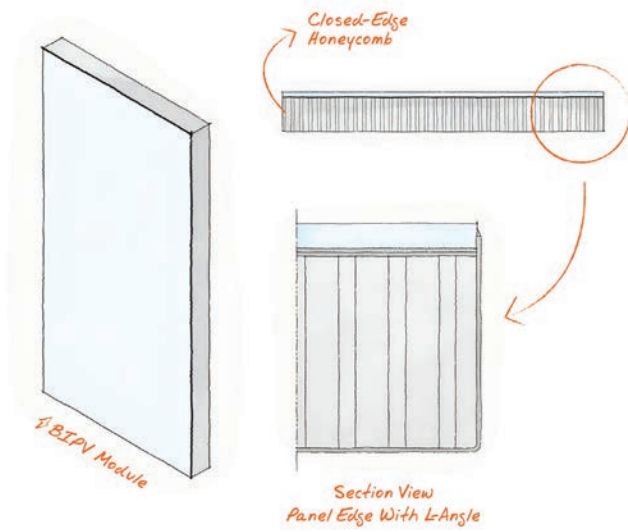

Module Edge

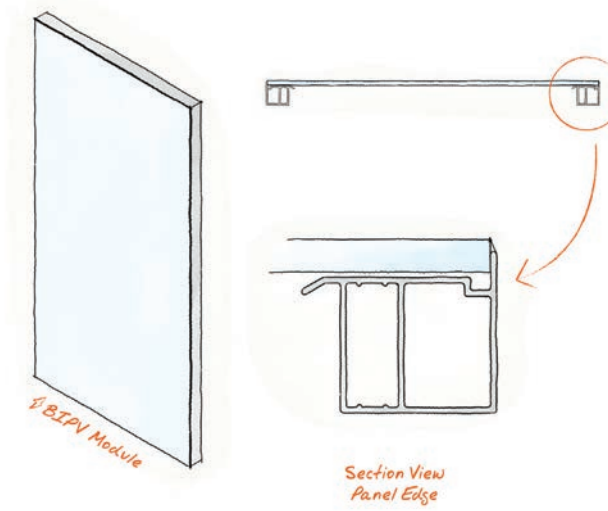

Module Return

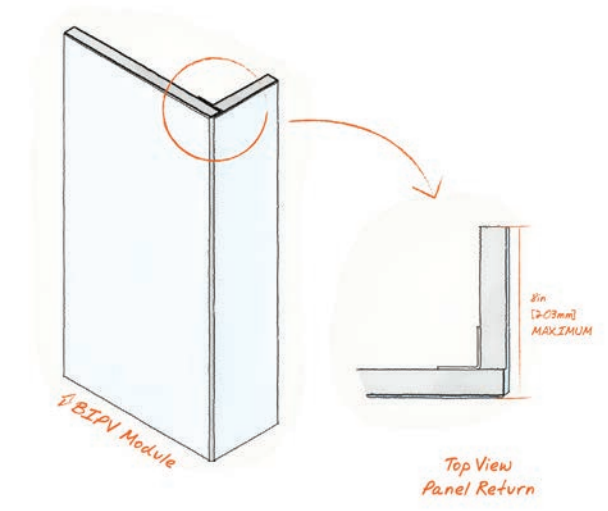

Module Return Site Assembled

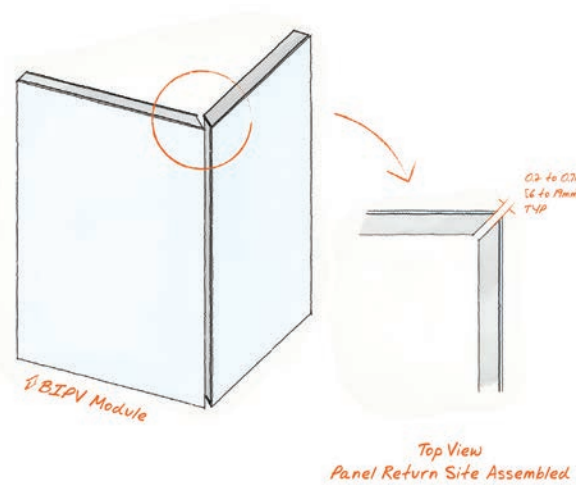

Module Return Pre-Assembled

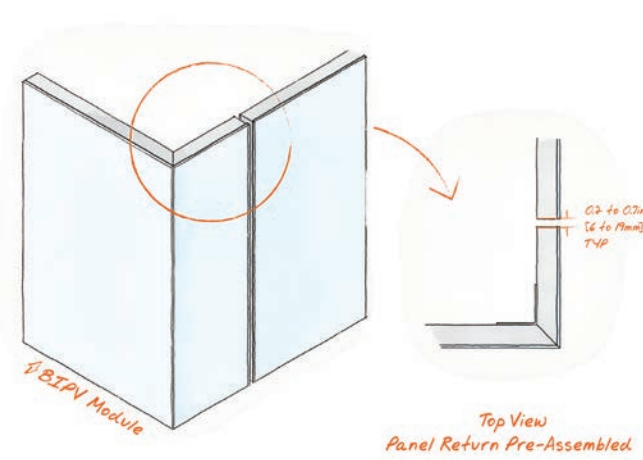

Module to Module

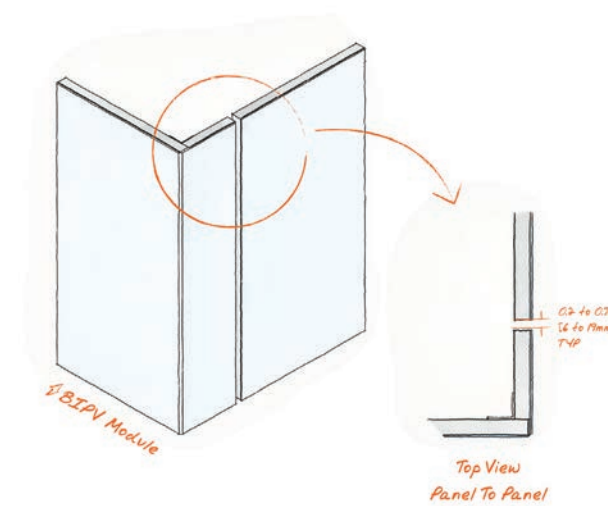

## Module Corners & Edges Details

### Extruded Aluminum Profile

## Module Tolerances Details

### Aluminum Honeycomb Backing

	Imperial	Metric
Dimensional Variation Length	± 0.11in	± 3mm
Dimensional Variation Width	± 0.11in	± 3mm
Thickness Tolerance	± 0.03in	± 1mm
Diagonal Difference	± 0.27in	± 7mm

### Extruded Aluminum Profile

	Imperial	Metric
Dimensional Variation Length	± 0.07in	± 2mm
Dimensional Variation Width	± 0.07in	± 2mm
Thickness Tolerance	± 0.03in	± 1mm
Diagonal Difference	± 0.19in	± 5mm

## Request Your Mitrex Architectural Box

The Mitrex Architectural Box is a curated toolkit that brings the potential of eFacade PRO+ directly to your hands. Designed with architects in mind, this box features a complete snapshot of our solar cladding system's capabilities — including a physical brochure, scaled-down corner and edge profiles, an active eFacade PRO+ sample, and a range of color chips showcasing our standard Genesis and Exodus finishes.

Whether you're exploring façade aesthetics, energy performance, or system integration, this box offers a tangible preview of what Mitrex can deliver.

Contact us at [info@mitrex.com](mailto:info@mitrex.com) to request your sample box today. Let's build the future — beautifully and sustainably.



**ORDER A FREE ARCHITECTURAL BOX!**  
Experience the look and feel of our solar cladding. Scan the QR code or visit [www.mitrex.com](http://www.mitrex.com) to order your free Mitrex architectural box today.



## Mitrex Design Assist Service

Mitrex and Clarity partner with architects and engineering teams from the earliest stages of design to co-develop integrated building envelope systems that satisfy both performance objectives and aesthetic goals. Through a structured Design Assist process, we offer façade system modeling, engineering validation, energy simulations, mock-up testing, and prefabrication strategies to streamline construction and reduce life cycle costs.

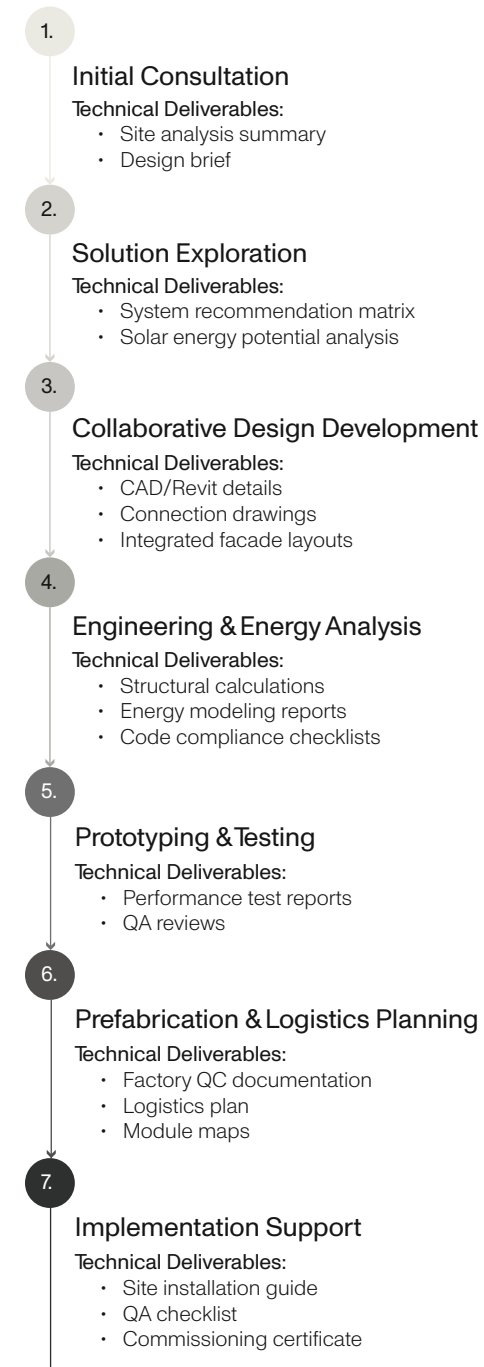

**Santander Tower, Miami, FL, USA**

ARCHITECT: Handel Architects  
GENERAL CONTRACTOR: Coastal Construction

ENGAGEMENT STEP: Design Development



**Cleo Parker Dance Studio, Denver, CO, USA**

ARCHITECT: Fentress Architects, Denver  
DEVELOPER: Cleo Parker Dance Studio

ENGAGEMENT STEP: Design Development

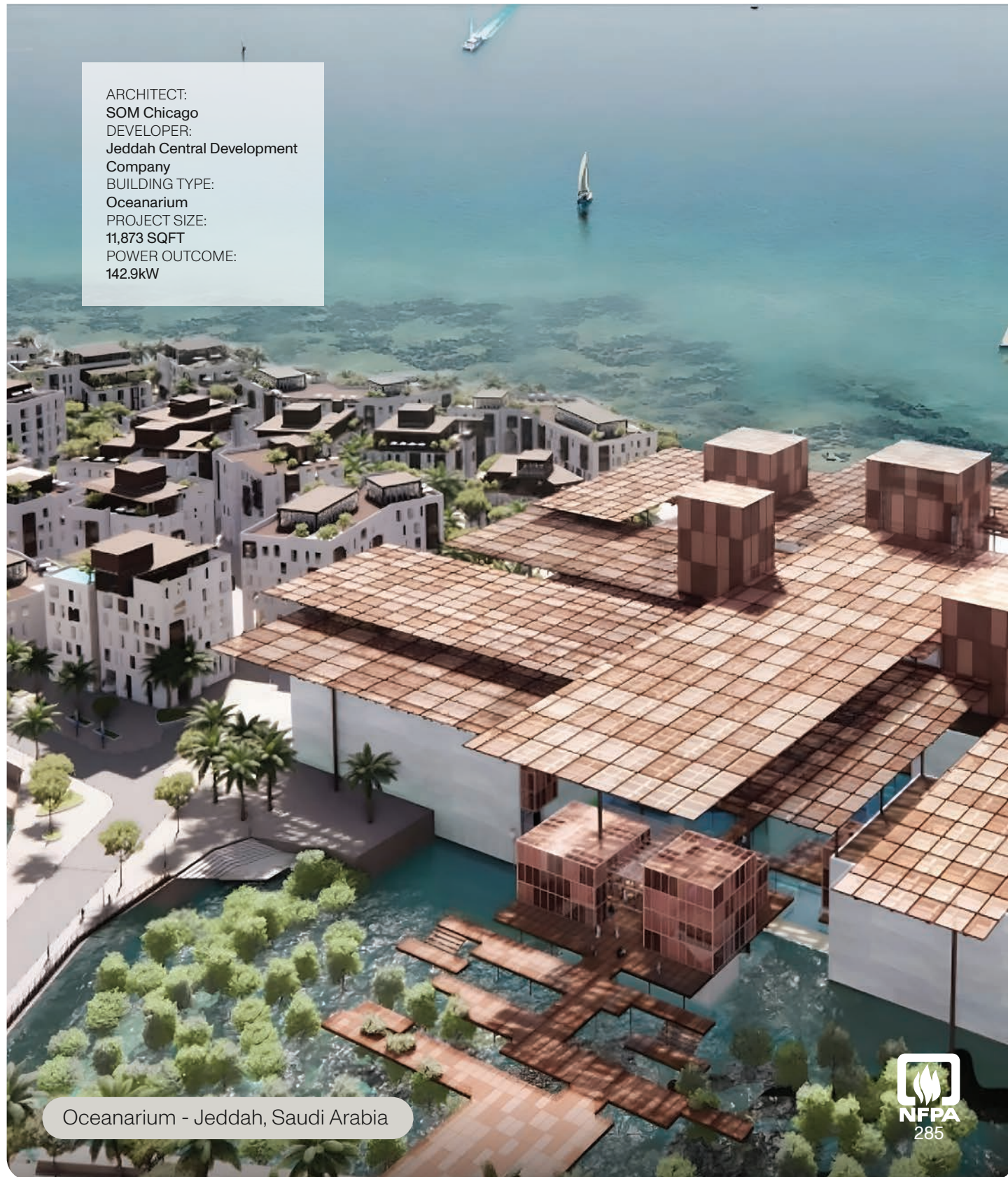

## Mitrex eFacade Products Comparison

Mitrex offers three distinct solar cladding solutions—eFacade LITE, eFacade PRO, and eFacade PRO+—each engineered to meet varying project needs in terms of design flexibility, performance, and scale.

The table below provides a detailed comparison across key features such as colors and finishes, sizing options, weight, system compatibility, and testing standards. Whether you're prioritizing affordability, customization, or advanced performance, this side-by-side overview will help you identify the best fit for your project.

	• eFacade LITE	• eFacade PRO	• eFacade PRO+
Colors & Patterns	5 color options	48 color options	Unlimited customizable colors & patterns
	Finish: Satin glass Thickness: 0.24in (6mm)	Finish: Satin glass Thickness: 0.24in (6mm)	Finish: Super satin, satin, matte, glossy, wood grain, aqualite, and more. Thickness: 0.12-0.47in (3.2-12mm)
Sizes & Weight	2 size options: 73 × 36 in (1854 × 922 mm) 73 × 18 in (1854 × 456 mm)	Custom sizes up to 80 × 39 in (2030 × 990mm).	Customizable single piece sizes up to 125 × 80 in (3,175 × 2,030mm). Preassembled pieces up to 420 inches (10.7m) long.
	Weight: 3.87 lb/SQFT (18.9 kg/sqm)	Weight: 3.84 lb/SQFT (18.8 kg/sqm)	Weight: 3.1 - 4.7 lb/SQFT (15.4-23.1 kg/sqm)
	Backing: Extruded aluminum profile with module thickness of 1.3in (34mm)	Backing: Extruded aluminum profile with module thickness of 1.3in (34mm)	Backing options: <u>Extruded aluminum profile with module thickness: 1.3in (34mm).</u>  <u>Aluminum honeycomb with module thickness:</u> • 1 in (25mm) honeycomb: 1.18in (30.2mm) - 1.23 in (33mm). • 2 in (50mm) honeycomb: 2.17in (55.2mm) - 2.28 in (58mm).
	Shapes: rectangle	Shapes: rectangle	Customizable Shapes: rectangle, triangle, circle, and more
Systems	Ventilated rainscreen system, eFacade LITE system	Ventilated rainscreen system (interlocking channel or anchor plate)	Customizable rainscreen, unitized or prefabricated system options
	System Thickness: 3.9in (101mm)	System Thickness: 1.5 in (39mm) - 2.32 (59mm)	System Thickness: 1.42 in (36mm) - 4.33in (110mm)
	MOQ of 5,000 SQFT (464.5 sqm)	MOQ of 5,000 SQFT (464.5 sqm)	MOQ of 25,000 SQFT (2,322.5 sqm)
Testing	3rd party tested	3rd party tested	3rd party tested
	Code-compliant & safety tested	Code-compliant & safety tested	Code-compliant & safety tested
	Fire tested	Fire tested	Fire tested

For more information about Mitrex eFacade products, visit [mitrex.com](http://mitrex.com) or email us at [info@mitrex.com](mailto:info@mitrex.com)

• Toll Free  
+1 (855) 254 0214

• Learn More  
[mitrex.com](http://mitrex.com)  
[info@mitrex.com](mailto:info@mitrex.com)

• Headquarters  
41 Racine Rd, Toronto, ON M9W2Z4, Canada  
+1 (416) 497 7120

• USA Office  
Chrysler Building, 405 Lexington Avenue Floor 26, New York, USA, 10174  
+1 (646) 583 4486

Mitrex and Cladify Projects

